

MICROWAVE TYPE
LEVEL SWITCH
MWS2-24TN/24RN

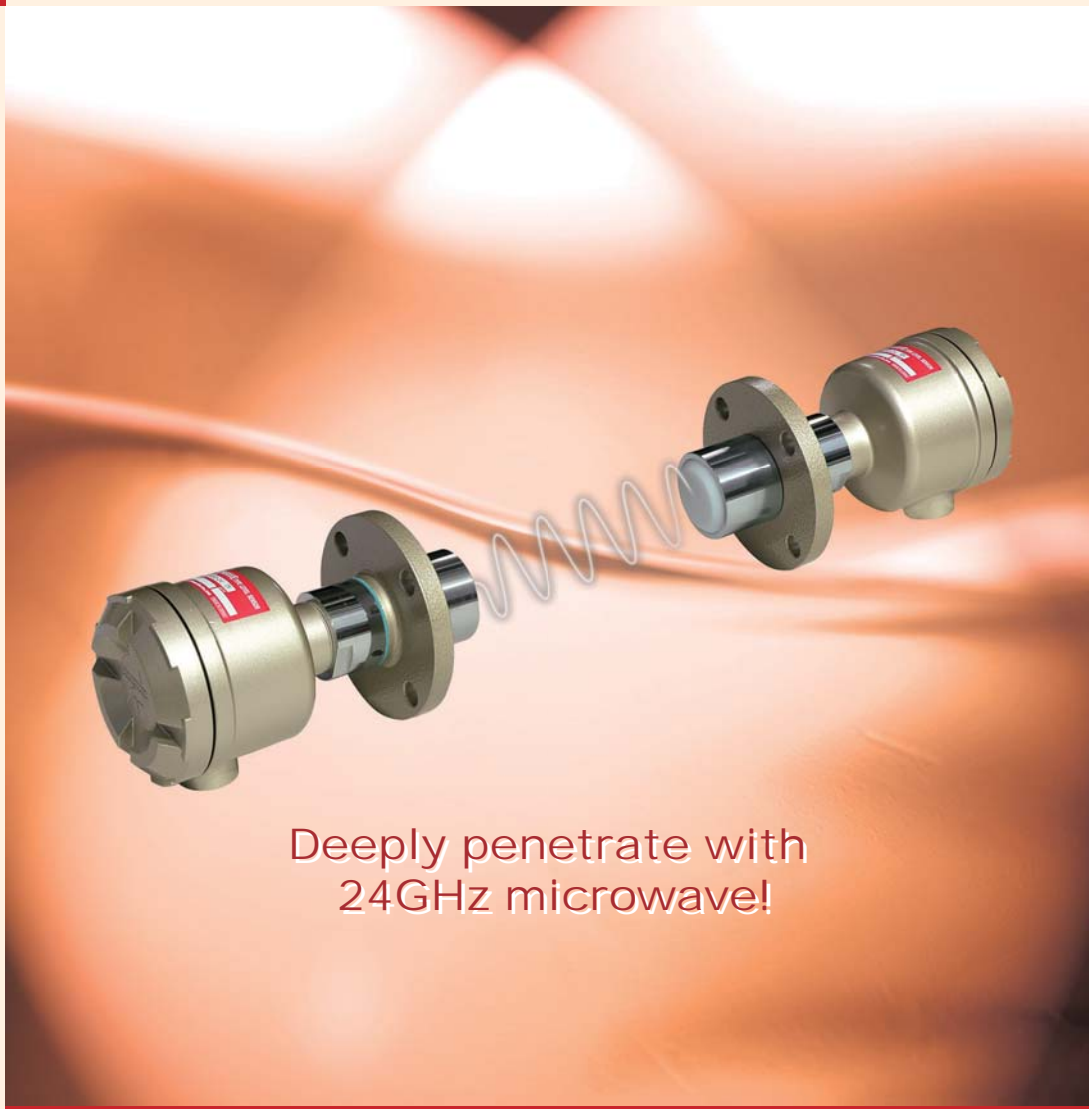

Deeply penetrate with
24GHz microwave!

**Microwave attenuation detects levels of powders,
granules, blocks, and grinds.**

MWS2-24TN/24RN

MICROWAVE TYPE LEVEL SWITCH

Reliable detection for wastes, coal, gravels, granules and other substances

24GHz Microwave - Compact, lightweight, and high-performance level switch.

- It is almost unaffected by dirt, adhesion, or scale on the sensor surface.
- A new type of transmitter and receiver of 24GHz is being adopted, compact and light.
- Wiring and adjustment are easier with a new amplifier.
- It can accurately detect the paper garbage, which was impossible by any other detecting methods.

■ Principle of Operation

MWS2 Type Microwave Switch is a level switch consisting of a transmitter and a receiver, both of which are installed face to face each other. The transmitter (MWS2-24TN) transmits microwaves in 24GHz toward the receiver (MWS2-24RN), which, upon receipt of them, provides an output of the contact signals of empty tank. When there is an obstruction between the transmitter and the receiver, however, microwaves are reflected and absorbed, thus making the receiver unable to receive them and outputting the contact signals of full tank.

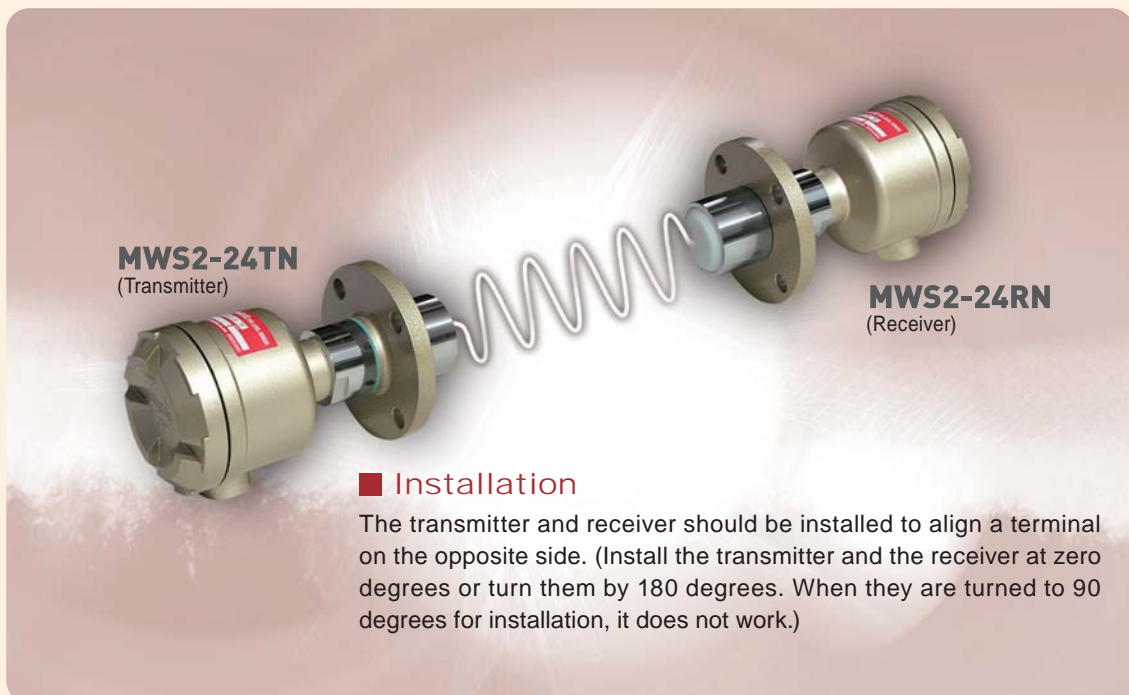

■ Installation

The transmitter and receiver should be installed to align a terminal on the opposite side. (Install the transmitter and the receiver at zero degrees or turn them by 180 degrees. When they are turned to 90 degrees for installation, it does not work.)

Specifications

Type Designation: Transmitter = MWS2-24TN
Receiver = MWS2-24RN

Power Supply: 105/210VAC ±10% 50/60Hz
*Option DC24V

Power Consumption: Transmitter 4VA, Receiver 5VA

Output Contact: 1xSPDT, 250VAC 5A max
ON Delay: About 10seconds (variable)
OFF Delay: About 10seconds (variable)

Frequency: 24GHz

Ambient Temperature: Amplifier -20°C to +60°C
Sensor -20°C to +80°C

* No freezing, no condensation

Enclosure Rating: IP67

Color: Gold

Weight: Transmitter 1.80kg Receiver 1.85kg

Flange: JIS5K50A (AC)

Product Lineup

MWS2-24TN/RN Standard Flange Type

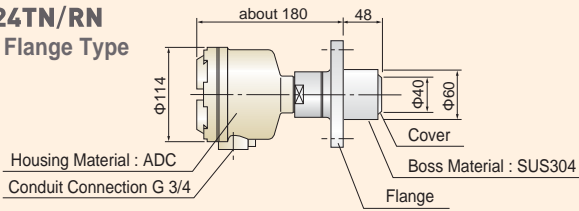

Temperature limit	max.80°C
Usage environment	Outdoor
Flange Size	JIS 5K50A/AC
Cover Material	PA
Setting distance	max.35m
Weight	Transmitter 1.8kg Receiver 1.85kg

JIS 5K65A, AC or SUS304 available

MWS2-24TN/RN-S Screw type

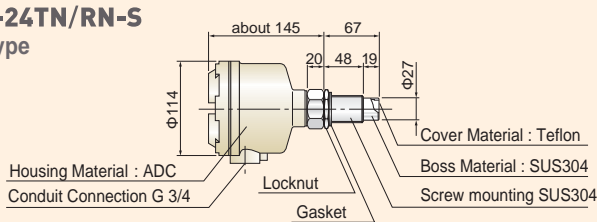

Temperature limit	max.80°C
Usage environment	Outdoor
Flange Size	G1B/SUS304
Cover Material	Teflon
Setting distance	max.2m
Weight	Transmitter 1.8kg Receiver 1.85kg

MWS2-24TN/RN-H2,H3,H3G Heat-resistant Type

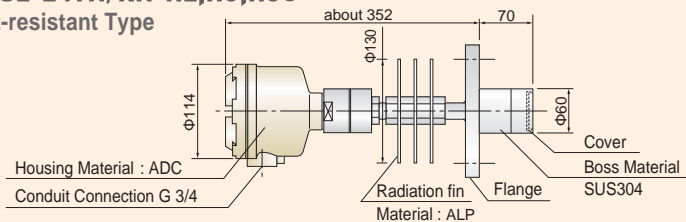

MODEL	Temperature limit	Gasket Material
MWS2-24TN/RN-H2	max.120°C	Nonasbestos
MWS2-24TN/RN-H3	max.260°C	Nonasbestos
MWS2-24TN/RN-H3G	max.400°C	Graphite

Usage environment	Outdoor
Flange Size	JIS 5K65A/SUS304
Cover Material	Teflon (H2) Ceramic (H3,H3G)
Setting distance	max.3m *Consult with us
Weight	Transmitter 4.9kg Receiver 4.95kg

MWS2-24TN/RN-H2,H3,H3G Heat-resistant Waveguide Extension Type

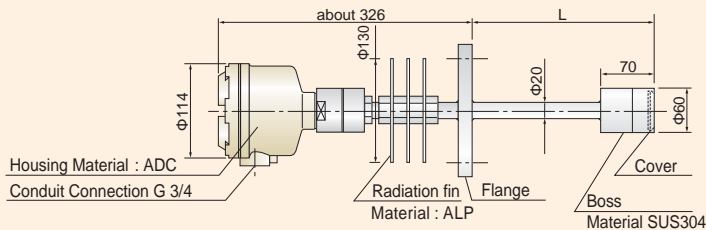

MODEL	Temperature limit	Gasket Material
MWS2-24TN/RN-H2	max.120°C	Nonasbestos
MWS2-24TN/RN-H3	max.260°C	Nonasbestos
MWS2-24TN/RN-H3G	max.400°C	Graphite

Usage environment	Outdoor
Flange Size	JIS 5K65A/SUS304
Cover Material	Teflon (H2) Ceramic (H3,H3G)
Setting distance	max.3m *Consult with us
Weight	Transmitter 5.2kg Receiver 5.25kg (L=150)

*L=min150-max please contact us.

MWS2-24TN/RN-H4 Super Heat-resistant Waveguide Extension Type

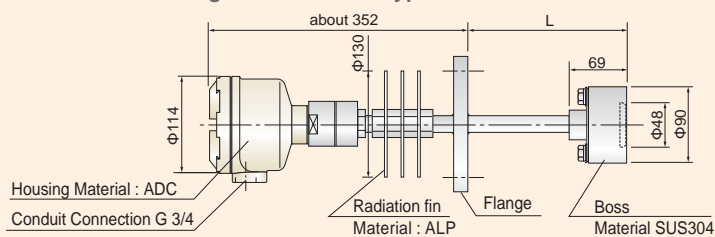

MODEL	Temperature limit	Gasket Material
MWS2-24TN/RN-H4	max.800°C	Metal Solid

Usage environment	Outdoor
Flange Size	JIS5K100A/SUS304
Cover Material	Ceramic
Setting distance	max.3m *Consult with us
Weight	Transmitter 8.2kg Receiver 8.25kg (L=150)

*L=min 150. Consult with us

MWS2-24TN/RN-R Remote Model

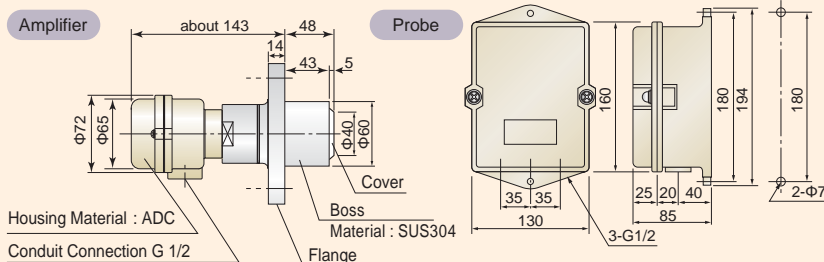

Temperature limit	max.60°C
Usage environment	Outdoor
Flange Size	JIS 5K50A/AC
Cover Material	PA
Setting distance	max.35m

JIS 5K65A, AC or SUS304 available

Wiring

Built In-Model

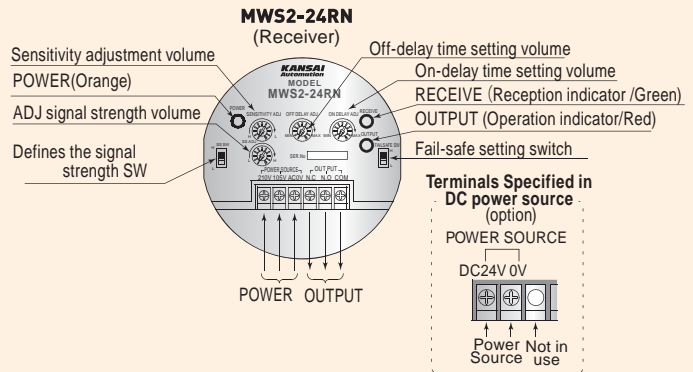
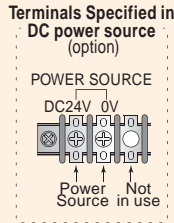
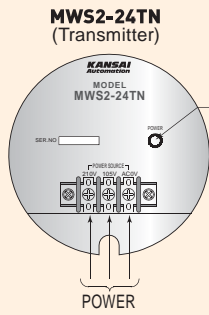

Remote Model

MWS2-24TN - R (Transmitter)

Amplifier of Remote Model

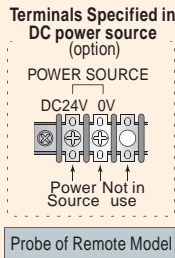
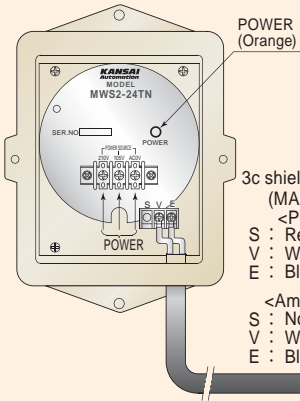

MWS2-24RN - R (Receiver)

Amplifier of Remote Model

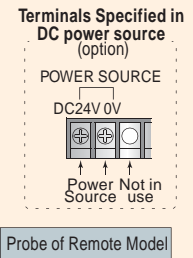
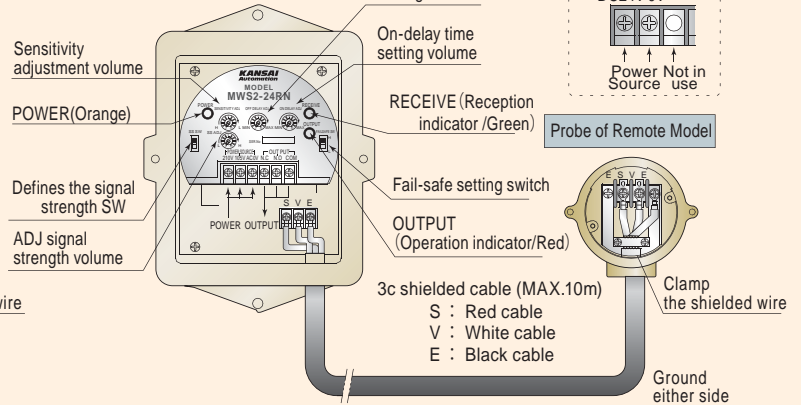

Type Designation

MWS2-24TN/RN-□□□□

Vibration-proof

Blank : Standard M : Resin molded amplifier

Heat resistance

Blank : Standard H3 : Radiator fin (Max.260°C)
H1 : Heatproof nozzle (Max.120°C) H3G : Radiator fin (Max.400°C)
H2 : Radiator fin (Max.120°C) H4 : Radiator fin (Max.800°C)

Mounting

Blank : Flange (Standard 5K50A) S : Screw (Standard G1B)

Instrument Structure

Blank : Integral type R : Remote amplifier type

Line of business

- Rotary Paddle Type Level Switch
- Vibration Type Level Switch
- Swing Type Level Switch
- Acoustic Level Switch
- Capacitance Type Level Switch
- Capacitive Proximity Sensor
- Capacitance Type Level Indicator
- Diaphragm Type Level Switch
- Tilt Switch
- Leak Type Level Switch
- Microwave Switch
- Sounding Bob Type Level Indicator
- Flow Switch
- Conductance Type Level Switch
- Float Switch
- Float Type Level Indicator
- Ultrasonic Type Level Indicator
- Equipments For Conveyor Lines
- Dust Monitor System
- Zirconia Oxygen Analyzer
- Laser Type Level Indicator
- RADAR Type Level Indicator
- Ultrasonic Flow meter

*Please be sure to read USER'S GUIDE, Installation & Operation Instructions before using the instrument.

*The specifications herein may be subject to change without advance notice.

General Manufacturer of Level Controllers for Powder, Granules, and Liquid

KANSAI Automation Co., Ltd.

Headquarters:

2-14, Togano-cho, Kita-ku, Osaka 530-0056, Japan
TEL. 81-6-6312-2071 FAX. 81-6-6314-0848
e-mail: info@kansai-automation.co.jp

<http://www.kansai-automation.co.jp>

Tokyo Branch: 1-29-6, Hamamatsu-cho, Minato-ku, Tokyo 105-0013, Japan
TEL. 81-3-5777-6931 FAX. 81-3-5777-6933

Nagoya Office: 3-10-17, Uchiyama, Chigusa-ku, Nagoya 464-0075, Japan
TEL. 81-52-741-2432 FAX. 81-52-741-1588

Hiroshima Office: 13-11, Noborimachi, Naka-ku, Hiroshima 730-0016, Japan
TEL. 81-82-222-1555 FAX. 81-82-222-1556

Kyushu Office: 1-1-21, Komemachi, Kokura Kita-ku, Kitakyushu 802-0003, Japan
TEL. 81-93-511-4741 FAX. 81-93-511-4580



Agent