

CAPACITANCE TYPE
LEVEL INDICATOR
KLI/KLT/KLG
SERIES



No Moving Part, Easy to Handle!!

Wide measuring span

Cement, etc



Unaffected by dust on pneumatic conveyor

Cement, etc



Unaffected by fouling

Flour, etc



Interfacial detection of two liquids



CLI/KLT/KLG SERIES

CAPACITANCE TYPE LEVEL INDICATOR

There being no moving part, it reliably operates for an extended period, and its maintenance is easy—best selling line in continuous measurement.

Features

- Reliable detection even during the materials feeding.
- It can be applied to powder, granules, and liquid.
- Not affected by dust, it can accurately indicate.
- It is possible to select one of the most suitable sensors from a wide range of products, depending on the applicable conditions. (high temperature, high pressure, strong acid/ alkali, conductivity, insulation property, and others)
- Safely measure a long span with electrodes designed to be strong enough.
- The intrinsically safe explosion-proof model is also available in hazardous areas.

Accurate detection of minimal capacitance

Adhesives, Lard (Food oil), Liquefied gas & others

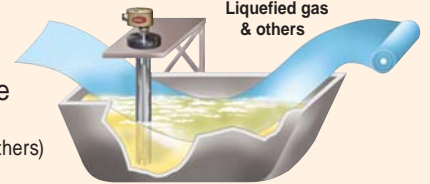

Operating Principle

When an electrode is set in a tank to be coaxial with its wall, as shown below, there forms a capacitance C_x between the tank and the electrode. By offsetting the stray capacitance of C_o , when the tank is empty, with a high-frequency impedance bridge, it is possible to obtain ΔC , namely the output electric signal, which is proportional to the height (level) l_1 of the material to be measured.

$$C_x = C_o + \Delta C$$

$$\Delta C = \frac{K(\epsilon_2 - \epsilon_1) l_1}{\log_{10}(R/r)}$$

(Increment of capacitance when the tank is filled with substances to be measured.)
 (C_o : Capacitance when the tank is empty,)
 (K = Constant)

Illustration of principle

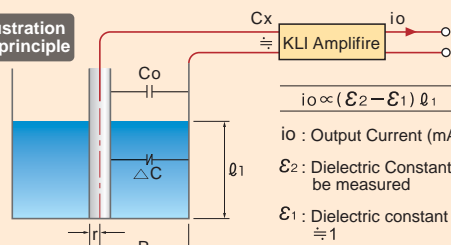

$$i_o \propto (\epsilon_2 - \epsilon_1) l_1$$

i_o : Output Current (mA)

ϵ_2 : Dielectric Constant of material to be measured

ϵ_1 : Dielectric constant of Air ≈ 1



model **KLI**

Agitating vessel
liquid, mud, etc.



Electrode / Amplifier Remote Type

(Outdoor wall mount)

- Length of Exclusive Cable: Max.50m (Sensitivity Class1 =Max.25m)
- 24VDC model can be available
- Electrostatic protective model can be manufactured.



Unaffected by static electricity

Resin pellet



model **KLG**

Intrinsically safe explosion-proof model
(i)2G4 TIIS No.T44622



- Attached safety barrier
- Exclusive cable : Max.25m

■ Applications

- | | | | |
|-------------------|-----------------|--------------|-------------|
| Molten resin | Organic solvent | | |
| Flour | Food oil | Heavy oil | |
| Sludge | Sulphuric acid | Caustic soda | |
| Industrial water | Fruit juice | Sea water | Waste water |
| Cement | Grain | Resin pellet | |
| Calcium carbonate | Powdered coal | | |
| Metal powder | | | |

model **KLT**

Electrode / Amplifier Built-in Type

- No exclusive cable is required.
- 24VDC model can be available.

KLI

**Electrode / Amplifier
Remote Type**

Can mount by screw-in, with IDF nuts, ferrule or ANSI and so on.

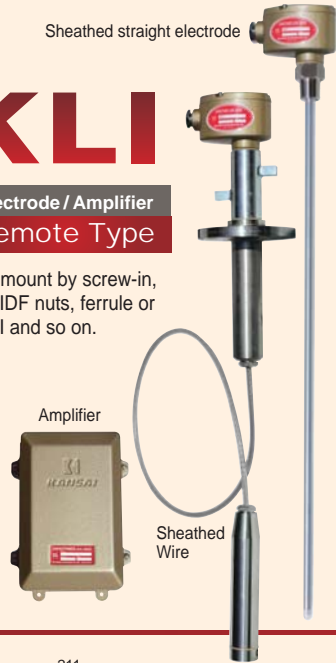

Electrode, Specification

Permissibly Distributed Capacitance : 0 – 400pF (Depending on shape)

Allowable Temperature : -25 – +80°C (Standard)
-200 – +500°C (Special)

Allowable Pressure : 1MPa (10kg/cm²) (Standard)

Enclosure Rating : IP-67

Color : Hammer-net gold

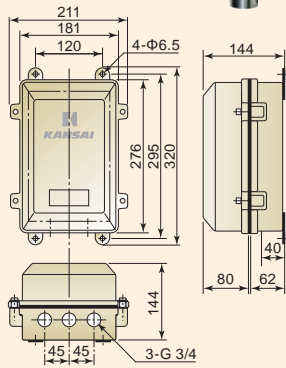
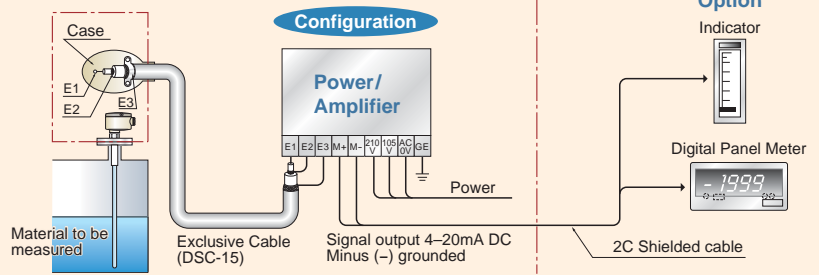

Power/Amplifier, Specification (Outdoor wall mounting)

Input Power Source : 105/210VAC ±10% 50/60Hz (24VDC available)

Power Consumption : 4VA

Output Signal : 4-20mA DC, 500Ω Max (-) ground

Measuring Sensitivity : 400pF, 1500pF, 6000pF, 30000pF (F.S)

Accuracy : (Amplifier) ±1%

Weight : 6.5Kg (Outdoor use)

Box Type : Outdoor Wall mounting or Panel built-in

Length of Exclusive Cable : Max. 50m (Sensitivity Class1=Max.25m)

Allowable Temperature : -20 – +60°C (No Condensation or Freeze required)

Enclosure Rating : IP-67

Color : Hammer-net gold

Specifications & Dimensions

*Below is a standard specifications and dimensions. Please contact your local sales agent for special specifications, such as heat-resistant and/or pressure-resistant specifications.

KLI-1□3 Special B31-Z-SP-65

Mounting : JIS10K80A
Temperature : -20 to +80°C
Pressure : 1MPa
Length of L : Max 4m

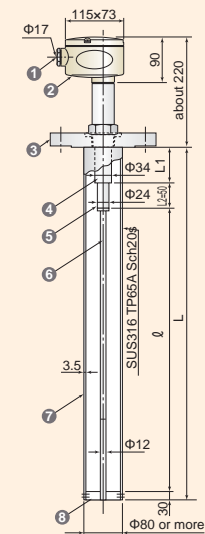

- 1 Cable Gland
- 2 Housing
- 3 Flange
- 4 Earth electrode
- 5 Insulator
- 6 Main electrode
- 7 Auxiliary electrode
- 8 Insulator supporter

KLI-2□3 K-P2-17

Mounting : JIS10K50A
Temperature : -20 to +80°C
Pressure : 1MPa
Length of L : Max 4m

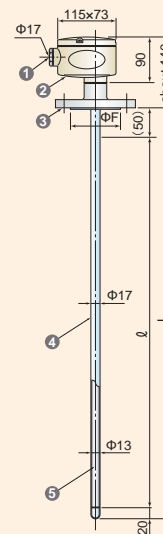

- 1 Cable gland C3604
- 2 Housing AC4B
- 3 Flange SUS304
- 4 Sheath Teflon
- 5 Main electrode SUS304

KLI-4□3 K-W-10P-(G)

Mounting : JIS10K65A
Temperature : -20 to +80°C
Pressure : 1MPa
Length of L : Max 15mm

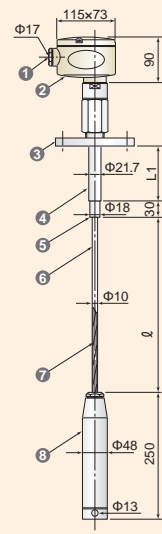

- 1 Cable gland C3604
- 2 Housing AC4B
- 3 Flange SUS304
- 4 Earth electrode SUS304
- 5 Insulator Polyacetal
- 6 Sheathed Teflon
- 7 Main electrode wire SUS304
- 8 Weight SUS304

KLI-4□3 K-W-15P-3

Mounting : JIS10K65A
Temperature : -20 to +80°C
Pressure : 1MPa
Length of L : Max 30m

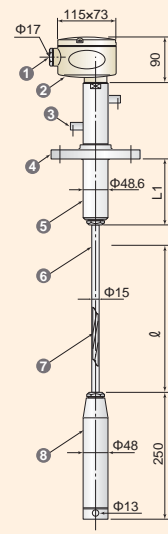

- 1 Cable gland C3604
- 2 Housing AC4B
- 3 Vent SS400
- 4 Flange SUS304
- 5 Earth electrode SUS304
- 6 Sheath Teflon
- 7 Main electrode wire SUS304
- 8 Weight SUS304

KLI-6□3 Pyrex K-P1-20-SP (50A)

Mounting : JIS10K65A
Temperature : -20 to +200°C
Pressure : 2MPa
Length of L : Max 1m

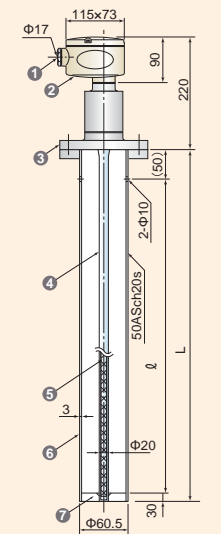

- 1 Cable gland C3604
- 2 Housing AC4B
- 3 Flange SUS304
- 4 Sheath Pyrex
- 5 Main electrode SUS304
- 6 Auxiliary electrode SUS304
- 7 Main electrode supporter Teflon

KLT

Electrode / Amplifier
Built-in Type

Can mount by screw-in,
with IDF nuts, ferrule or
ANSI and so on.

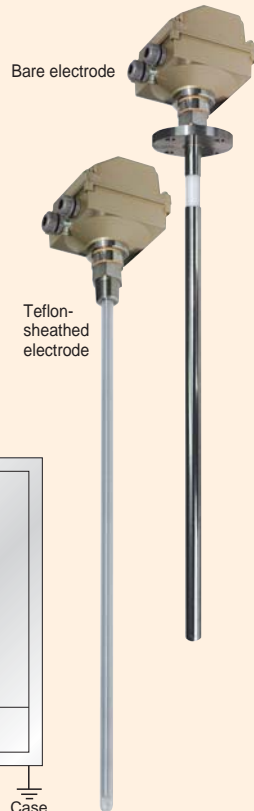

Standard Specification

- Input Power Source : 105 /210VAC ±10% 50/60Hz (24VDC available)
- Power Consumption : 4VA
- Output Signal : 4 – 20mA DC, (500Ω Max) Minus (-) grounded
- Measuring Sensitivity : 800pF, 2000pF, 7000pF, 30000pF (F.S)
- Accuracy : ±1%
- Permissibly Distributed Capacitance : 0 – 400pF (Depending on shape)
- Allowable Temperature : -25 – +80°C (Standard)
-200 – +500°C (Special)
- Maximum Pressure : 980kPa
- Enclosure Rating : IP-67
- Color : Hammer-net gold

Wiring Diagram

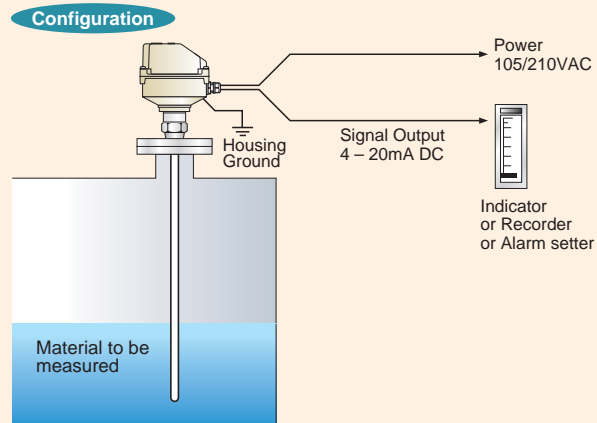
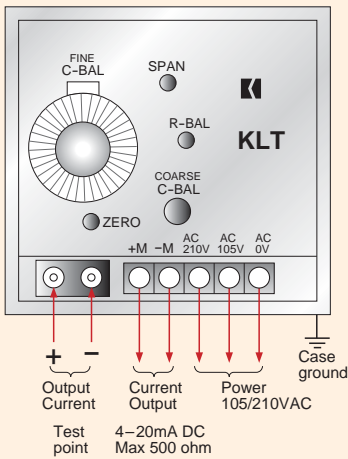

Specifications & Dimensions *Below is a standard specifications and dimensions. Please contact your local sales agent for special specifications, such as heat-resistant and/or pressure-resistant specifications.

KLT-2□□ T-P1-17-IN1.5S

Mounting : IDF1.5S
Temperature : -20 to +60°C
Pressure : 300kPa
Length of L : Max 4m

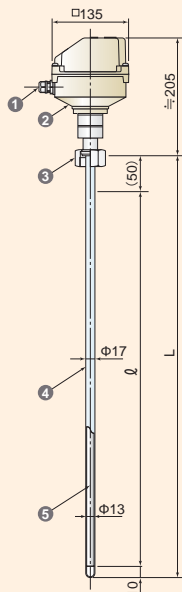

- 1 Cable gland Polyacetal
- 2 Housing ADC
- 3 IDF Union nut SUS304
- 4 Sheath Teflon
- 5 Main electrode SUS304

KLT-2□□ T-P1-17-IF1.5S

Mounting : IDF1.5S
Temperature : -20 to +60°C
Pressure : 1MPa
Length of L : Max 4m

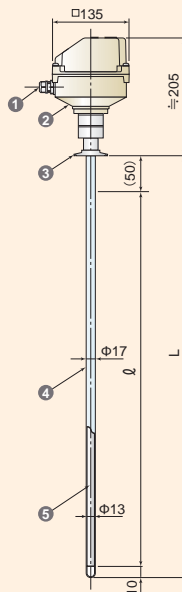

- 1 Cable gland Polyacetal
- 2 Housing ADC
- 3 IDF Ferrule SUS304
- 4 Sheath Teflon
- 5 Main electrode SUS304

KLT-3□□-H^{Special} T-W8-B3-H3

Mounting : JIS10K50A
Temperature : -20 to +400°C
Pressure : 1MPa
Length of L : Max15m

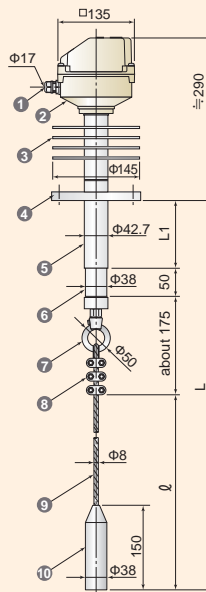

- 1 Cable gland Polyacetal
- 2 Housing ADC
- 3 Fin AC
- 4 Flange SUS304
- 5 Earth electrode SUS304
- 6 Insulator Ceramic
- 7 Eye nut SUS304
- 8 Wire clip SUS304
- 9 Main electrode SUS304
- 10 Weight SUS304

KLT-4□□ T-W-10P-L

Mounting : JIS5K50A
Temperature : -20 to +60°C
Pressure : 1MPa
Length of L : Max15m

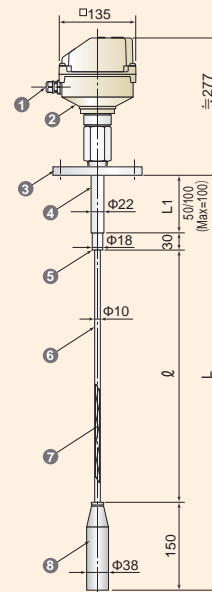

- 1 Cable gland Polyacetal
- 2 Housing ADC
- 3 Flange SUS304
- 4 Earth electrode SUS304
- 5 Insulator Polyacetal
- 6 Sheath Teflon
- 7 Main electrode wire SUS304
- 8 Weight SUS304

KLG

Intrinsically safe explosion-proof model (i)2G4 TIS No.T44622

For Hazardous Gas Environment
Explosion-proof available
Certified by Technology Institution of Industrial Safety



Safety Barrier
MTL728+
Fuse Built-in type

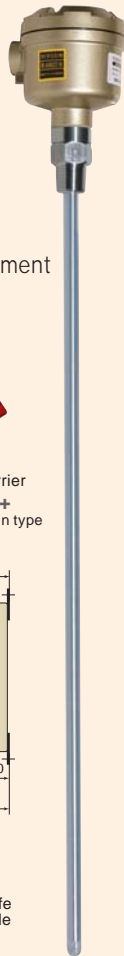
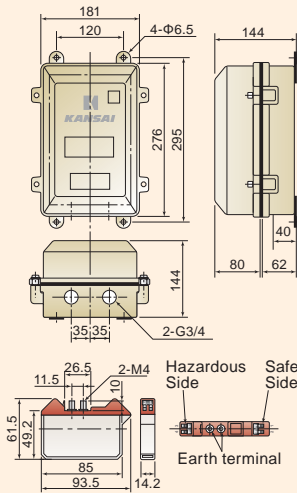

Can safely be used at any hazardous environment.

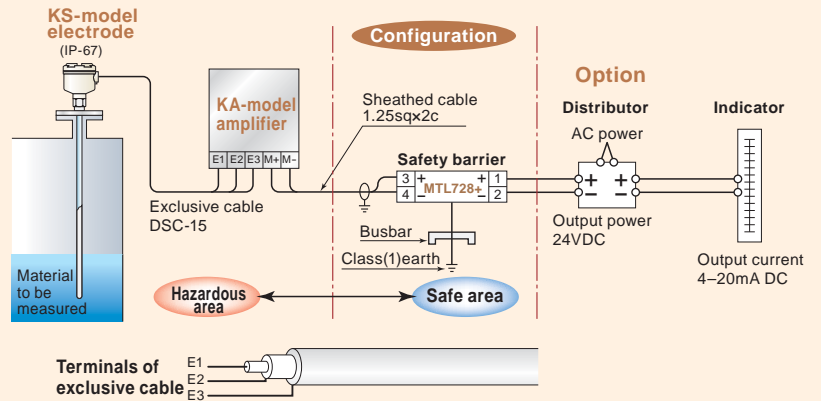

Amplifier, Specification

- Power Consumption : 4 VA
- Output Signal : 4 – 20mA DC (100Ω Max)
- Measuring Sensitivity : 130pF, 300pF, 3000pF (F.S)
- Accuracy : (Amplifier) ±1%
- Weight : 6.0 kg
- Housing : Outdoor Wall mounting
- Length of Exclusive Cable : Max.25 m
- Enclosure Rating : IP-67
- Painting Color : Hammer-net gold

Power, Specification (Option)

- Distributor: 100 /110VAC or 200 /220V
- Allowable load resistance 600Ω Max (Using Model 7552 made by Tsuruga Electric Corp.)



Distributor

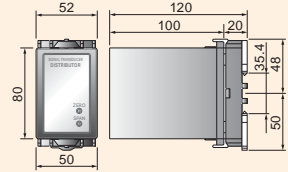

Specifications & Dimensions *Below is a standard specifications and dimensions. Please contact your local sales agent for special specifications, such as heat-resistant and/or pressure-resistant specifications.

KLG-2□3 G-P1-17-SP(40A)

Mounting : JIS10K50A
Temperature : -20 to +80°C
Pressure : 1MPa
Length of L : Max 4m

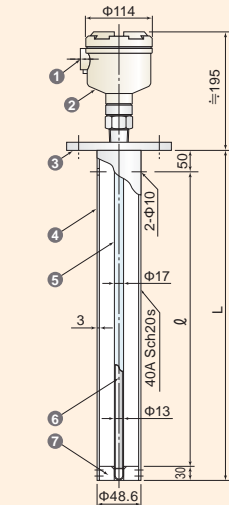

- 1 Cable gland G 3/4
- 2 Housing ADC
- 3 Flange SUS304
- 4 Auxiliary electrode SUS304
- 5 Sheath Teflon
- 6 Main electrode SUS304
- 7 Main electrode supporter Teflon

KLG-2□3 G-P1-17

Mounting : R1
Temperature : -20 to +80°C
Pressure : 1MPa
Length of L : Max 4m

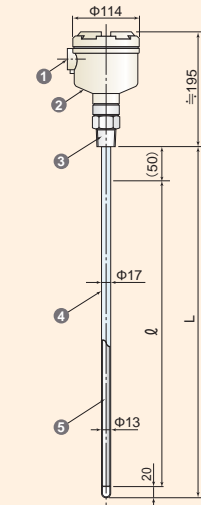

- 1 Cable gland G 3/4
- 2 Housing ADC
- 3 Screw SUS304
- 4 Sheath Teflon
- 5 Main electrode SUS304

KLG-2□3 G-P1-17-IF-1S

Mounting : IDF ferrule 1S
Temperature : -20 to +80°C
Pressure : 1MPa
Length of L : Max 4m

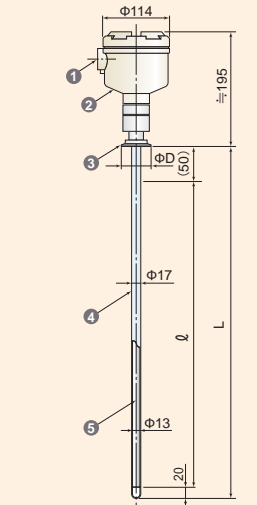

- 1 Cable gland G 3/4
- 2 Housing ADC
- 3 IDF Ferrule SUS304
- 4 Sheath Teflon
- 5 Main electrode SUS304

KLG-4□3 G-W-10P-L

Mounting : JIS10K50A
Temperature : -20 to +80°C
Pressure : 1MPa
Length of L : Max 15m

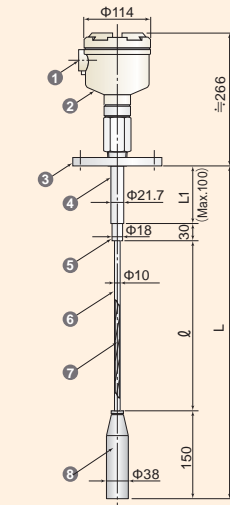

- 1 Cable gland G 3/4
- 2 Housing ADC
- 3 Flange SUS304
- 4 Earth electrode SUS304
- 5 Insulator Polyacetal
- 6 Sheath Teflon
- 7 Main electrode wire SUS304
- 8 Weight SUS304

Optional Units



Meter Relay LV1000-AI-A2

Power supply : AC85 to 264V (50/60Hz)
 DC12 to 24V $\pm 10\%$ (Option)
 Power consumption : Max.23VA(Option DC type 10W)
 Sensor supply voltage : DC24V $\pm 5\%$ Max.150mA
 Analog Current : DC4 to 20mA
 Output : (Resistance load Max.500 Ω)
 Alarm contact output : AC250V 0.3A /DC30V 2A
 Feature : 21 points linearize function,
 Max. 4 points available for
 alarm contact output
 (2 points for standard)

SAFTY BARRIERS MTL728+

Approval Proof : Intrinsically Safe
 Safty Discription : Intrinsically Safe circuit

Max Volts	28V
Max Current	93mA
Max Power	650mW
Intrinsically Safe Circuit	
Permissible Volts	250VAC
	250VDC

Permissible Capacitance : 0.047 μ F
 Permissible Inductance : 2.75mH
 Working Volts : 25.5VDC
 Working Current : 50mADC
 Temperature : 60 $^{\circ}$ C



Tension Test Osaka Prefectural Industry Technology Research, 2/24/84

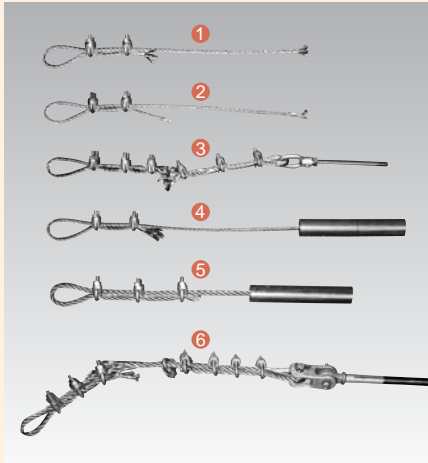

Name of parts for tension test

- 1 $\Phi 8$ wire rope at lead brazing
- 2 Same as above. For preventing the falling
- 3 $\Phi 8$ wire rope/ eyenut
- 4 $\Phi 8$ wire rope/ bob Weight
- 5 $\Phi 12$ wire rope/ bob Weight
- 6 $\Phi 12$ wire rope/ eyebolt

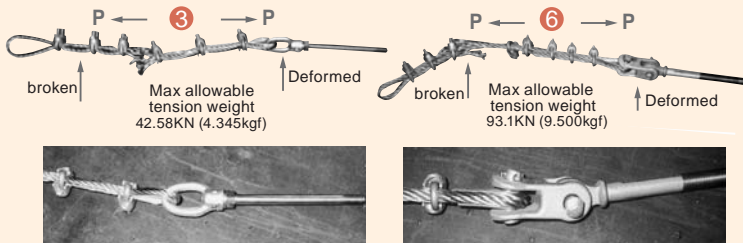

3 Description of Deformed Part

The eyenut ring ovalizes but does not crack. No exception is noted on the screw-thread part of stainless steel bar.

3 $\Phi 8$ Wire

Eyenut Method. An eyenut and a heart thimble deform but withstand any breakage. The withstanding weight is 4.345 tons. The official tension shear weight of the wire is 4.13 tons.

6 Eyebolt Portion of $\Phi 12$ Wire

A right-angled crevice and a heart thimble deform but withstand any breakage. The withstanding weight is 9.5 tons. The official tension shear weight of the wire is 9.48tons.

6 Description of Deformed Part

Two pins of right-angled crevice, the lower half of the crevice and a pin-hole of the eyebolt as well as a heart thimble were metamorphosed. The left pin and the lower half of the crevice were severely damaged. The right pin and the eyebolt hole were metamorphosed by about 1mm.

Type Designation

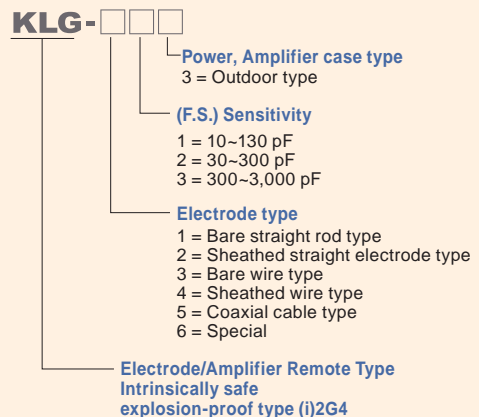
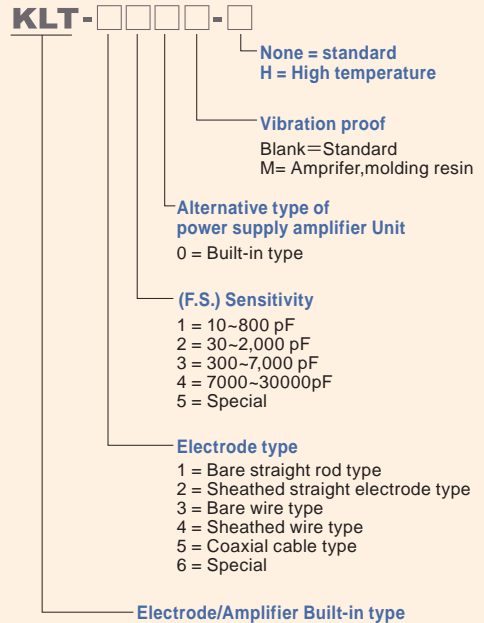
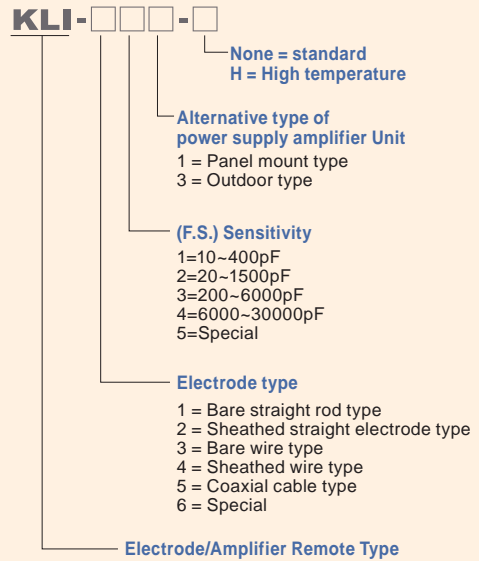

*As for the model of "Pyrex" and "Special", please check with our Sales staff.

Please inform us of the following when inquiring and ordering

1. Name of substance to be measured	[]
2. Dielectric constant, Specific resistance	[]
3. Particle size	[]
4. Viscosity / Agglomerating	[Yes • No
5. Corrosive	[Yes • No
6. Foamy	[Yes • No
7. Tank Material	[]
8. Tank Shape (1.Circular, 2.Square)	[]
9. Agitator	[Yes • No
10. Service Temperature / °C	[°C
11. Service Pressure / Pa	[Pa
12. Length of Exclusive Cable (Supplied with the sensor)	[]
13. Type of Amplifier Housing	[]
14. Indicator and other ancillary equip.	[Yes • No

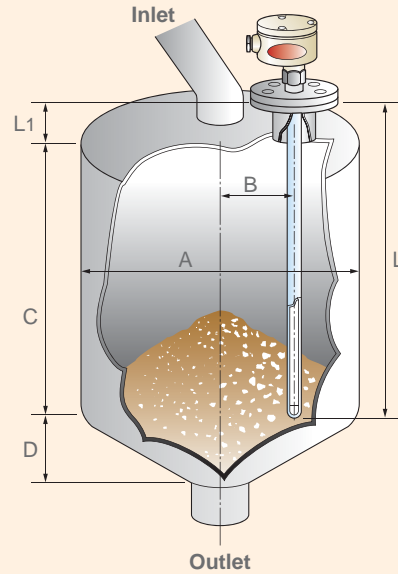

Caution

You may come across some indication errors under the varied conditions as follows:

1. Varied water content of a material to be measured
2. Varied dielectric constant of a material to be measured
3. Varied particle size of a material to be measured

■ Fill out the following blanks:

A Tank Diameter	[]
B Installation Location	[]
L Length of Electrode	[]
L1 Height of Nozzle installed	[]
∅ Measuring Span	[]
C Height of Tank's Cylindrical Part	[]
D Height of Tank's Conical Part	[]

Line of business

- Rotary Paddle Type Level Switch
- Vibration Type Level Switch
- Swing Type Level Switch
- Acoustic Level Switch
- Capacitance Type Level Switch
- Capacitive Proximity Sensor
- Capacitance Type Level Indicator
- Diaphragm Type Level Switch
- Tilt Switch
- Leak Type Level Switch
- Microwave Switch
- Sounding Bob Type Level Indicator
- Flow Switch
- Conductance Type Level Switch
- Float Switch
- Float Type Level Indicator
- Ultrasonic Type Level Indicator
- Equipments For Conveyor Lines
- Dust Monitor System
- Zirconia Oxygen Analyzer
- Laser Type Level Indicator
- RADAR Type Level Indicator
- Ultrasonic Flow meter

*Please be sure to read USER'S GUIDE, Installation & Operation Instructions before using the instrument.

*The specifications herein may be subject to change without advance notice.

General Manufacturer of Level Controllers for Powder, Granules, and Liquid



KANSAI Automation Co., Ltd.

Headquarters :

2-14, Togano-cho, Kita-ku, Osaka 530-0056, Japan
 TEL. 81-6-6312-2071 FAX. 81-6-6314-0848
 e-mail: info@kansai-automation.co.jp

<http://www.kansai-automation.co.jp>



official site



Tokyo Branch: 1-29-6, Hamamatsu-cho, Minato-ku, Tokyo 105-0013, Japan
 TEL. 81-3-5777-6931 FAX. 81-3-5777-6933

Nagoya Office: 3-10-17, Uchiyama, Chigusa-ku, Nagoya 464-0075, Japan
 TEL. 81-52-741-2432 FAX. 81-52-741-1588

Hiroshima Office: 13-11, Noborimachi, Naka-ku, Hiroshima 730-0016, Japan
 TEL. 81-82-222-1555 FAX. 81-82-222-1556

Kyushu Office: 1-1-21, Komemachi, Kokura Kita-ku, Kitakyushu 802-0003, Japan
 TEL. 81-93-511-4741 FAX. 81-93-511-4580

Agent

--